

TRUSS LAYOUT OPTIMIZATION EMBEDDED IN A CONTINUUM

TOMAS ZEGARD – GLAUCIO H. PAULINO

TABLE OF CONTENTS

- 1 – INTRODUCTION & MOTIVATION
- 2 – LINKAGE FORMULATION
- 3 – OPTIMIZATION DIFFICULTIES
- 4 – CONVOLUTION FORMULATION
- 5 – COMPARISON & ANALYSIS
- 6 – VERIFICATION
- 7 – EXAMPLES & RESULTS
- 8 – CONCLUSION

1 – INTRODUCTION & MOTIVATION

- WHY DISCRETE—CONTINUUM?
 - LIMITED MODELING CAPABILITY
 - REASONABLE SIMPLIFICATIONS OF REALITY

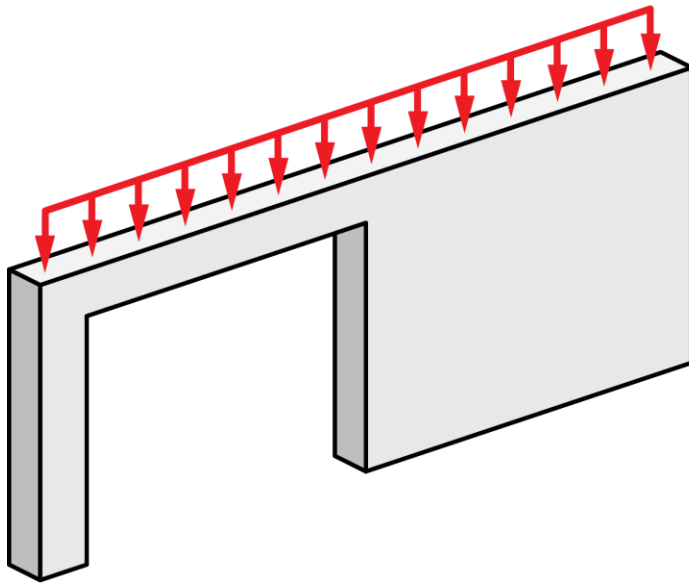

REAL FRAME

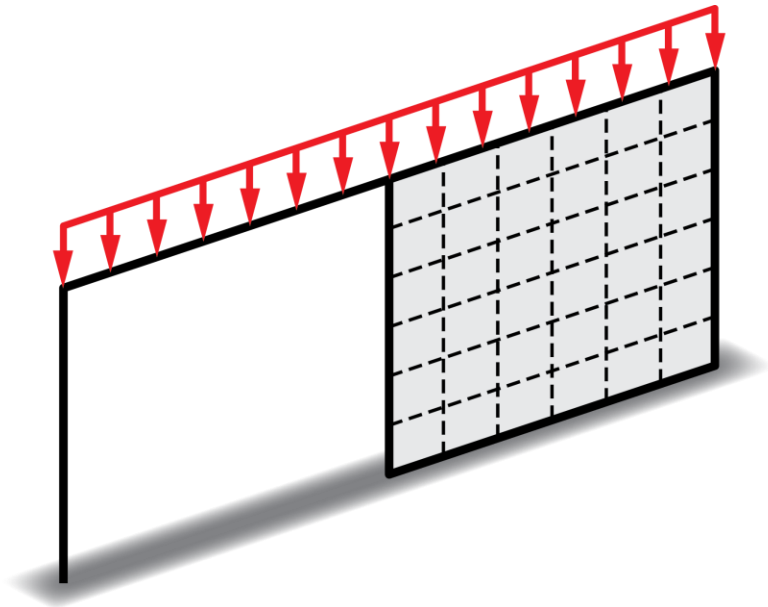

SIMPLIFIED FRAME MODEL

1 – INTRODUCTION & MOTIVATION

- CONTINUUM OPT W. DISCRETE ELEMENTS

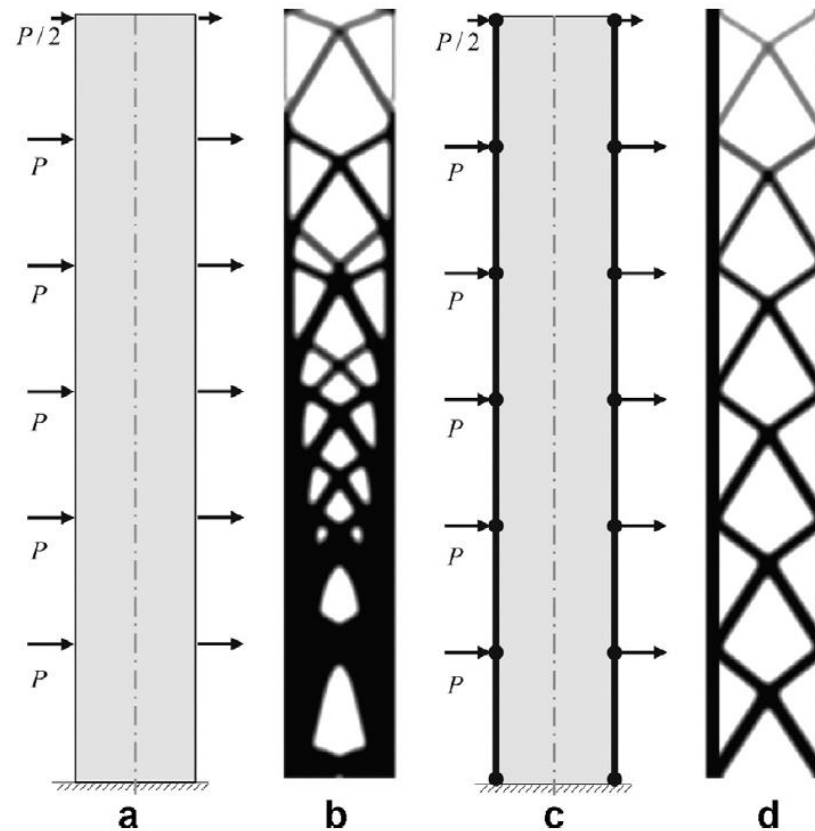

STROMBERG L L, BEGHINI A, BAKER W F, PAULINO G H (2012) – “TOPOLOGY OPTIMIZATION FOR BRACED FRAMES: COMBINING CONTINUUM AND BEAM/COLUMN ELEMENTS”, ENGINEERING STRUCTURES 27, PP 106–124

1 – INTRODUCTION & MOTIVATION

- SLAB WITH SUPPORTING CABLES

SELF WEIGHT OF SLAB

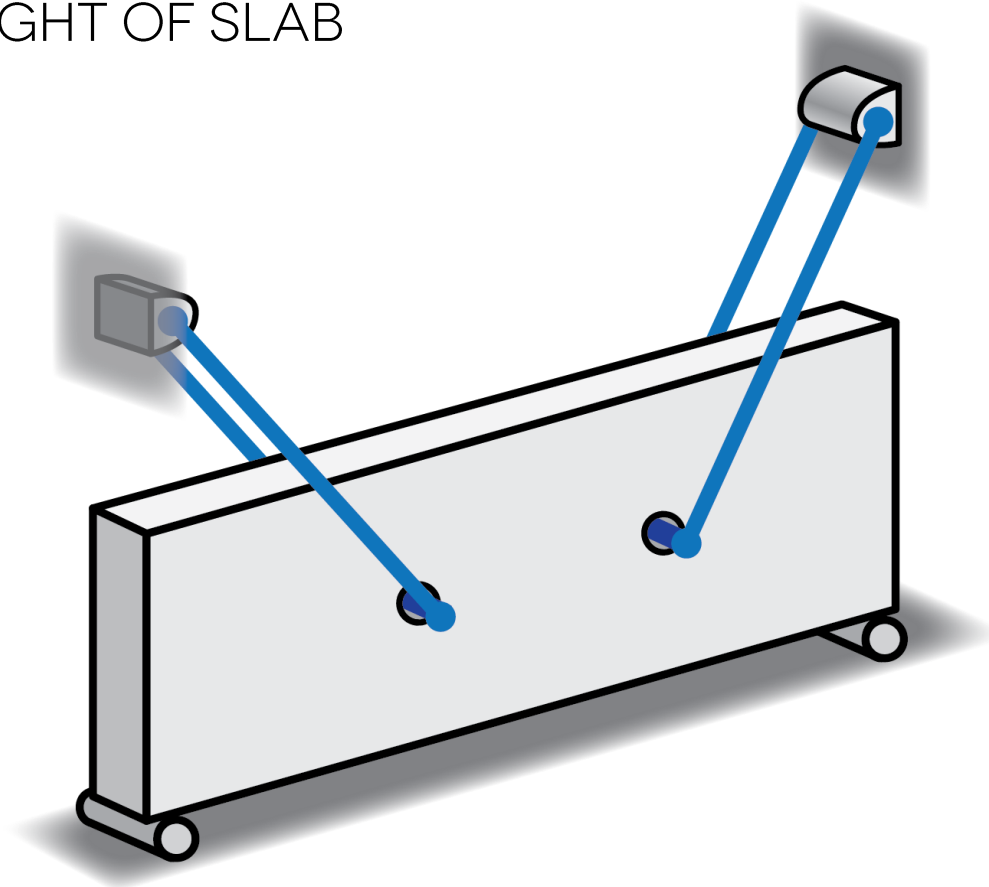

1 – INTRODUCTION & MOTIVATION

- SLAB WITH SUPPORTING CABLES

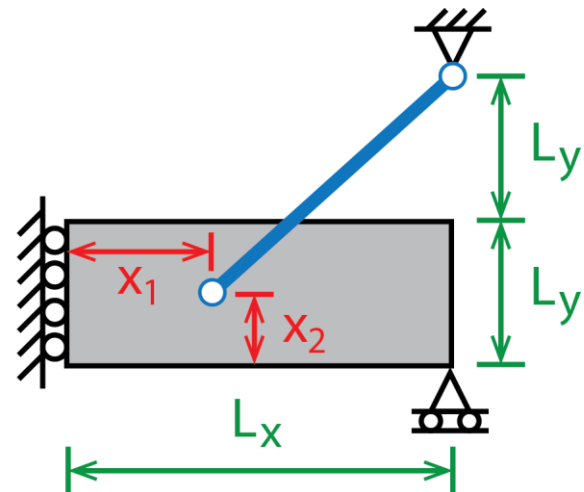
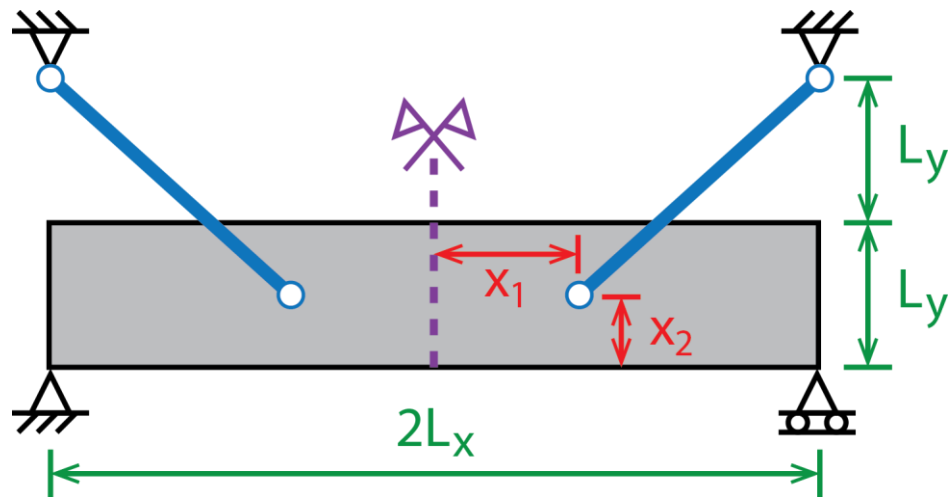

2 - LINKAGE FORMULATION

- TRUSS ELEMENT

$$\mathbf{K}^* = \frac{AE}{L} \begin{bmatrix} 1 & -1 \\ -1 & 1 \end{bmatrix}$$

$$\mathbf{K}_e = \mathbf{T}_e^T \mathbf{K}_e^* \mathbf{T}_e$$

$$\mathbf{d} = \frac{1}{L} [x_2 - x_1, y_2 - y_1, z_2 - z_1]$$

$$\mathbf{T} = \begin{bmatrix} \mathbf{d} & \mathbf{0} \\ \mathbf{0} & \mathbf{d} \end{bmatrix}$$

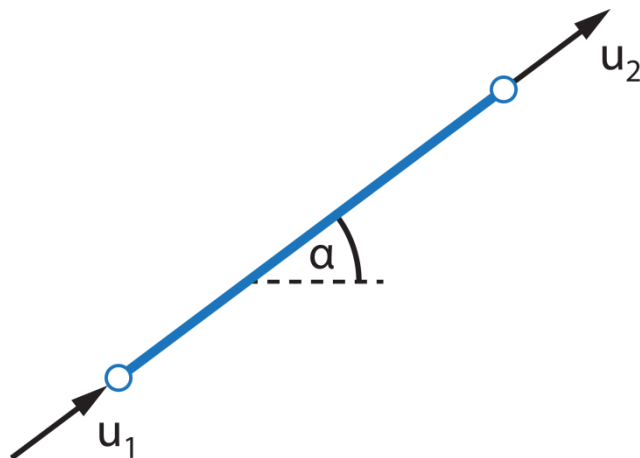

LOCAL COORDINATES

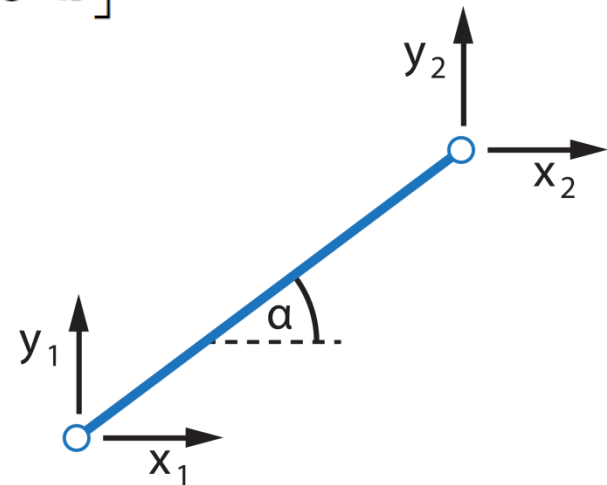

GLOBAL COORDINATES

2 – LINKAGE FORMULATION

- SENSITIVITY W.R.T COORD ‘N’ OF NODE ‘J’

$$\frac{\partial \mathbf{K}_e}{\partial n_j} = \frac{\partial \mathbf{T}_e^T}{\partial n_j} \mathbf{K}_e^* \mathbf{T}_e + \mathbf{T}_e^T \frac{\partial \mathbf{K}_e^*}{\partial L} \frac{\partial L}{\partial n_j} \mathbf{T}_e + \mathbf{T}_e^T \mathbf{K}_e^* \frac{\partial \mathbf{T}_e}{\partial n_j}$$

$$\frac{\partial L}{\partial n_1} = -\mathbf{d}_n \qquad \frac{\partial L}{\partial n_2} = \mathbf{d}_n$$

$$\frac{\partial \mathbf{K}^*}{\partial L} = -\frac{AE}{L^2} \begin{bmatrix} 1 & -1 \\ -1 & 1 \end{bmatrix}$$

$$\mathbf{J}_{(1)}(\mathbf{d}) = \frac{1}{L} (\mathbf{d}^T \mathbf{d} - \mathbf{I}) \qquad \mathbf{J}_{(2)}(\mathbf{d}) = -\mathbf{J}_{(1)}(\mathbf{d})$$

2 – LINKAGE FORMULATION

- DISPLACEMENTS “U” ANYWHERE IN Ω USING FEM SHAPE FUNCTIONS

$$\mathbf{u} = \mathbf{N}\mathbf{u}_c$$

- CONFORMING COUPLING
 - TRUSS MEMBER’S \mathbf{K}_e IS COUPLED BY AN EQUIVALENT \mathbf{K}_e^+ MATRIX

$$\mathbf{u}^T \mathbf{K}_e \mathbf{u} = \mathbf{u}_c^T \mathbf{K}_e^+ \mathbf{u}_c$$

$$(\mathbf{N}\mathbf{u}_c)^T \mathbf{K}_e (\mathbf{N}\mathbf{u}_c) = \mathbf{u}_c^T \mathbf{K}_e^+ \mathbf{u}_c$$

$$\mathbf{u}_c^T (\mathbf{N}^T \mathbf{K}_e \mathbf{N}) \mathbf{u}_c = \mathbf{u}_c^T \mathbf{K}_e^+ \mathbf{u}_c$$

$$\mathbf{N}^T \mathbf{K}_e \mathbf{N} = \mathbf{K}_e^+$$

2 – LINKAGE FORMULATION

- COMPLIANCE FORMULATION

$$\min_{\mathbf{A}, \mathbf{x}} \quad C = \mathbf{u}^T \mathbf{K} \mathbf{u} = \mathbf{u}^T \mathbf{f}$$

$$\text{s.t.} \quad \sum_i A_i L_i \leq \bar{V} \quad \leftarrow \text{REQUIRED IF MEMBERS ARE ALSO SIZED}$$

$$\text{with} \quad \mathbf{K} \mathbf{u} = \mathbf{f}$$

3 - OPTIMIZATION DIFFICULTIES

- 3X9 MESH (Q4 ELEMS)

SLAB: $LX=2$ $LY=0.8$ $E=100$ $\nu=0.3$

CABLE: $AE=300$

LOAD: $B=[0 \ -2]$

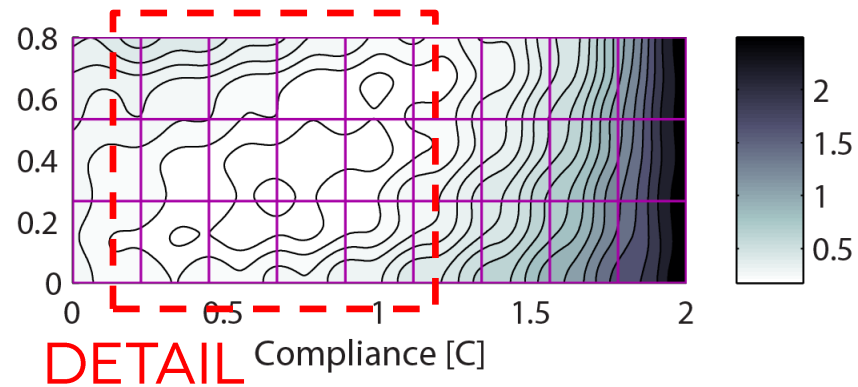
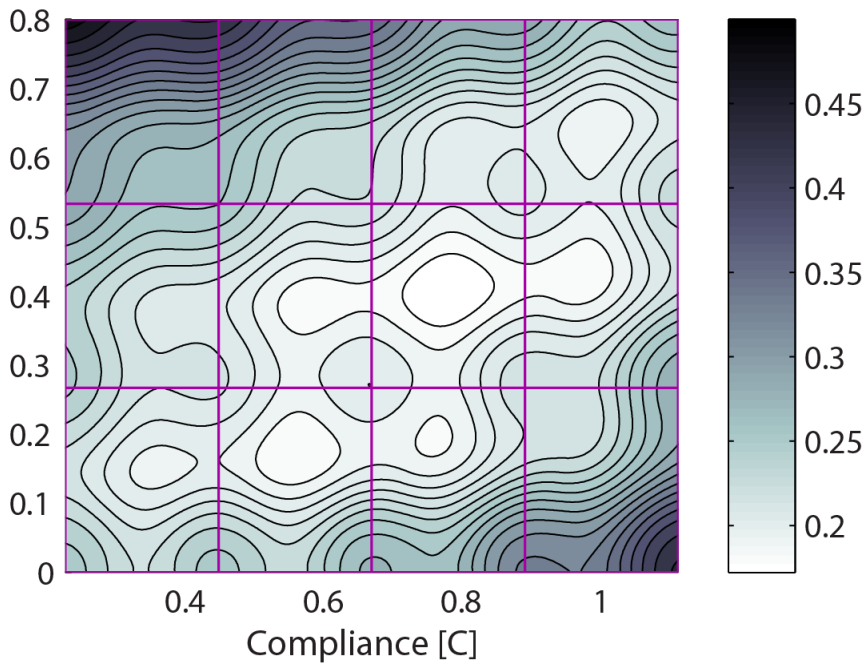
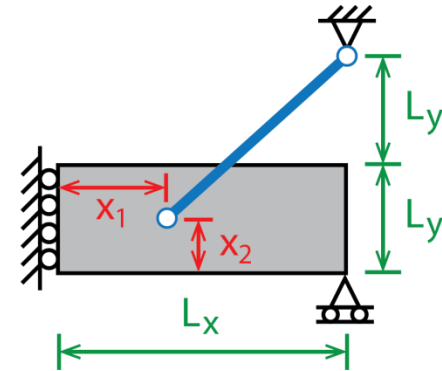

3 - OPTIMIZATION DIFFICULTIES

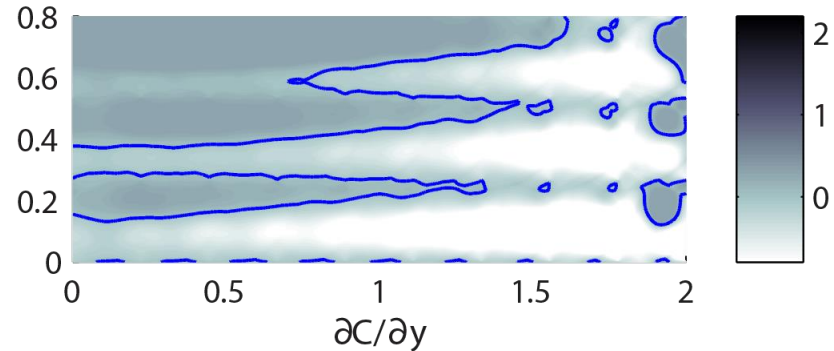
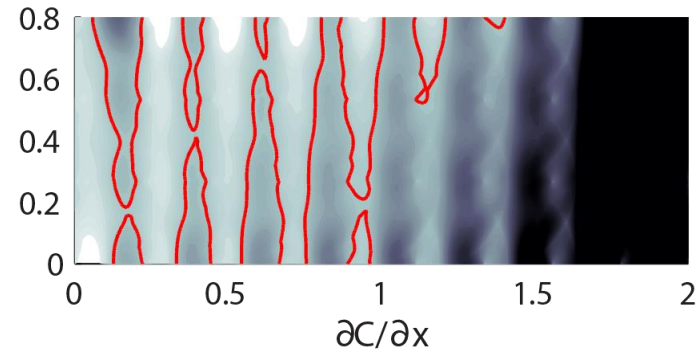
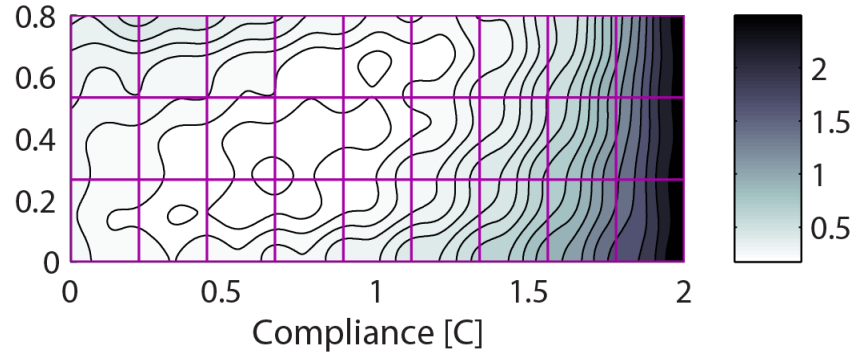

GLOBAL
OPTIMUM

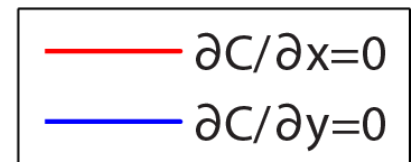
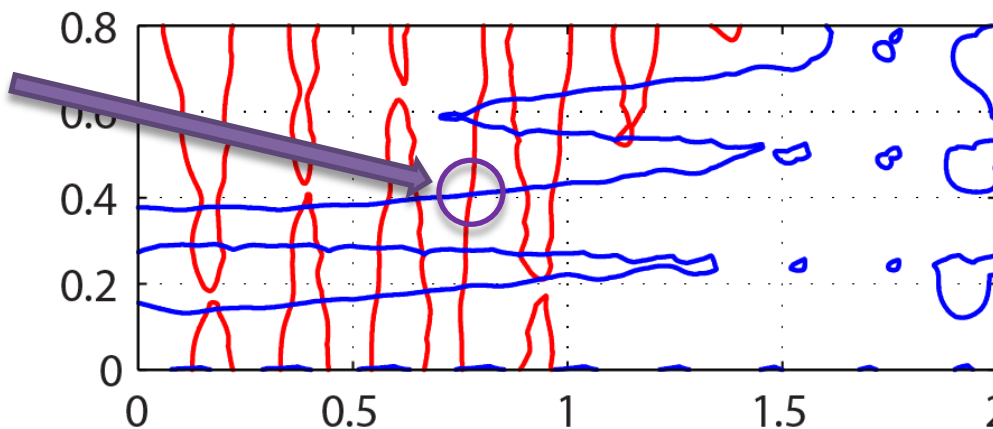

3 - OPTIMIZATION DIFFICULTIES

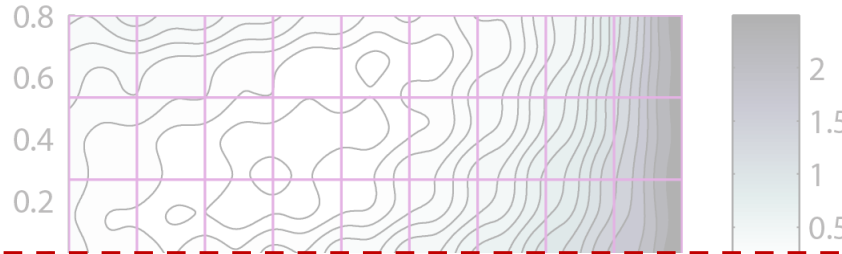

SO WHAT
NOW?

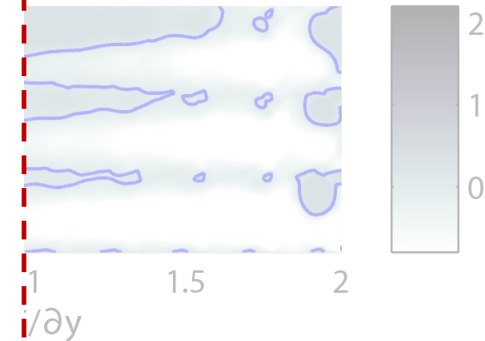
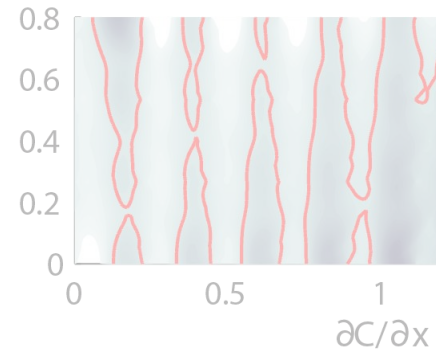

GLOBAL
OPTIMUM

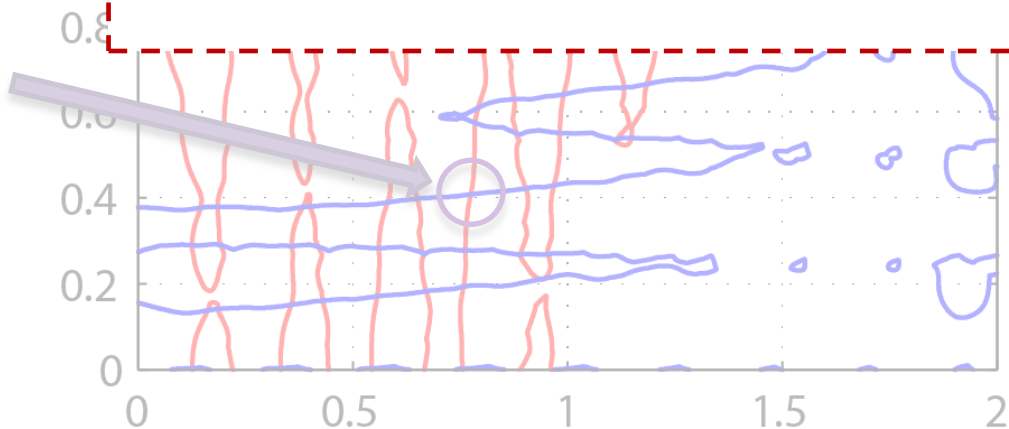

4 – CONVOLUTION FORMULATION

- GAUSSIAN BLUR
 - CONVOLUTION WITH A GAUSSIAN FUNCTION



4 - CONVOLUTION FORMULATION

- ARBITRARILY SMOOTH CONVOLUTION?

$$\begin{aligned} h(0) &= 1 \\ h(r \geq R) &= 0 \\ \left. \frac{dh}{dr} \right|_{r=R} &= 0 \end{aligned}$$

REQUIREMENTS

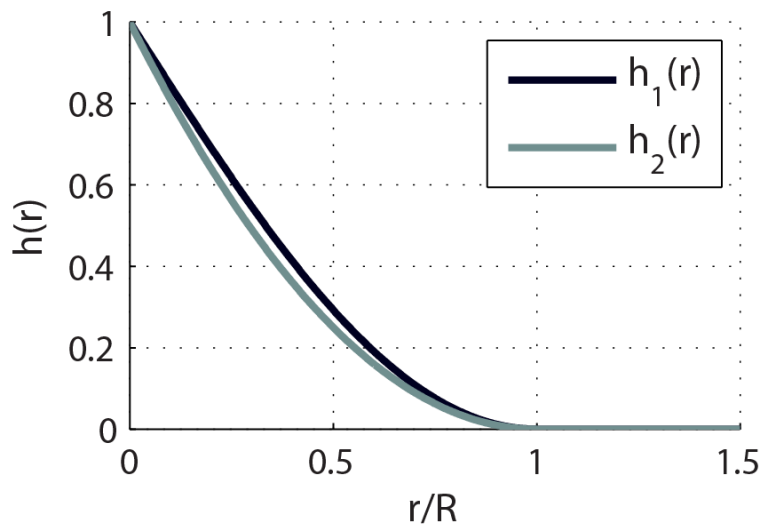

$$h_1(r) = \begin{cases} 1 - \sin\left(\frac{r\pi}{2R}\right) & r \leq R \\ 0 & r > R \end{cases}$$
$$h_2(r) = \begin{cases} \left(\frac{r}{R}\right)^2 - 2\left(\frac{r}{R}\right) + 1 & r \leq R \\ 0 & r > R \end{cases}$$

4 – CONVOLUTION FORMULATION

- CONVOLUTION-BASED SHAPE FUNCTIONS
 - PARTITION OF UNITY REQUIREMENT

$$\tilde{N}_a = \frac{h(r_a)}{\sum_k h(r_k)}$$

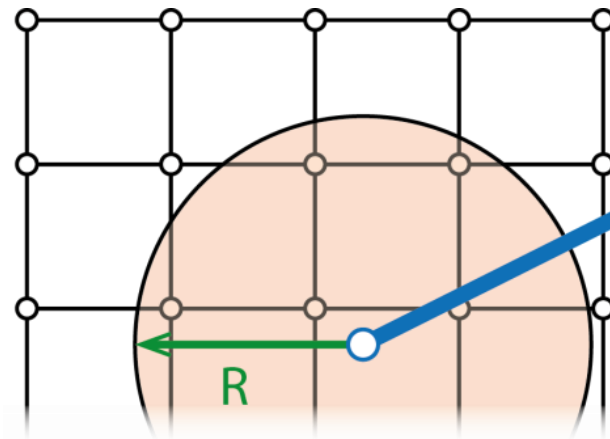

$$\mathbf{K}_e^+ = \tilde{\mathbf{N}}^T \mathbf{K}_e \tilde{\mathbf{N}}$$
$$\frac{\partial \mathbf{K}_e^+}{\partial n_j} = \frac{\partial \tilde{\mathbf{N}}^T}{\partial n_j} \mathbf{K}_e \tilde{\mathbf{N}} + \tilde{\mathbf{N}}^T \frac{\partial \mathbf{K}_e}{\partial n_j} \tilde{\mathbf{N}} + \tilde{\mathbf{N}}^T \mathbf{K}_e \frac{\partial \tilde{\mathbf{N}}}{\partial n_j}$$

4 – CONVOLUTION FORMULATION

- EFFICIENT CONVOLUTION SEARCH
 - BINARY, QUAD & OCT TREES

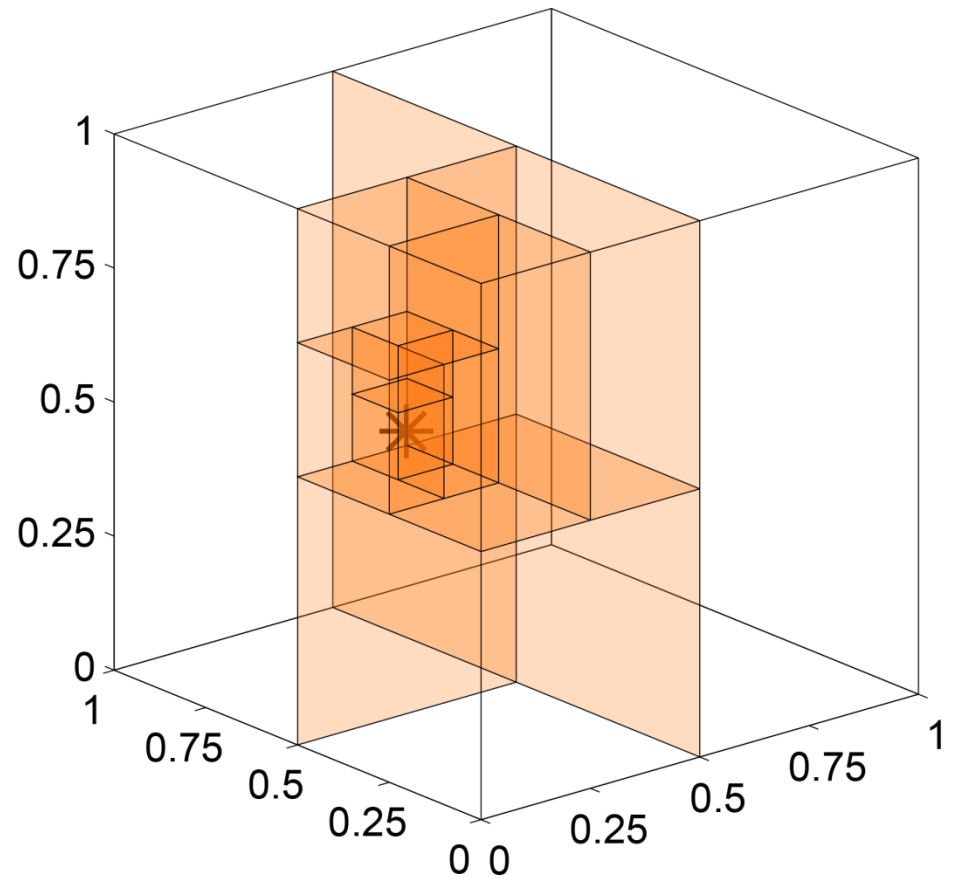
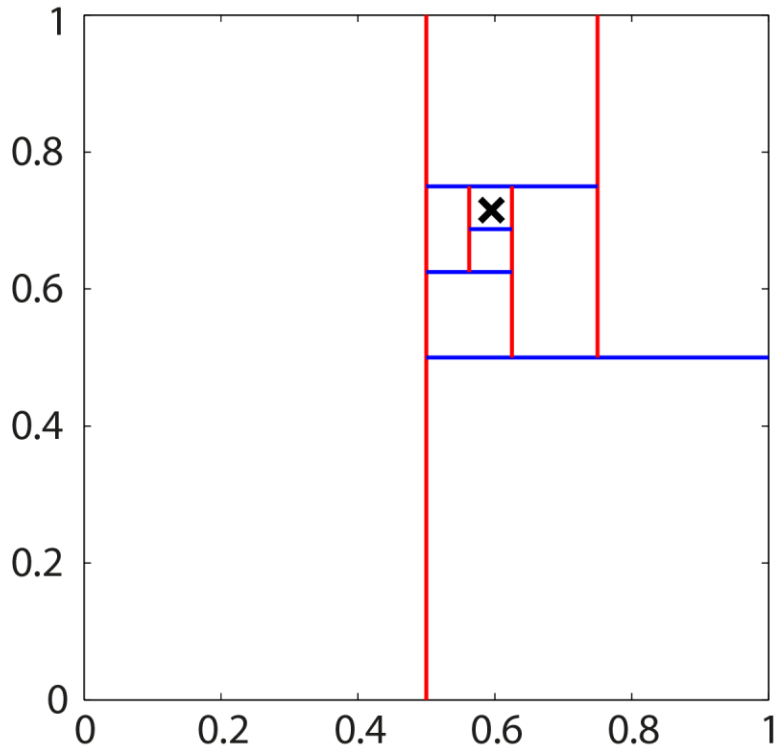

5 - COMPARISON & ANALYSIS

FEM SHAPE FUNCTIONS

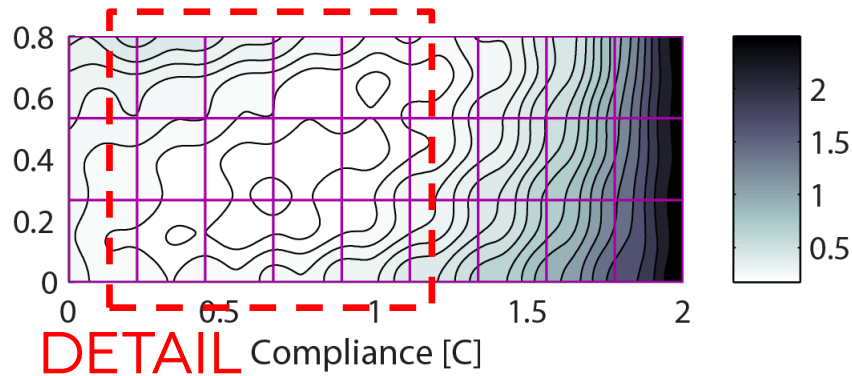

CONVOLUTION (R=0.5)

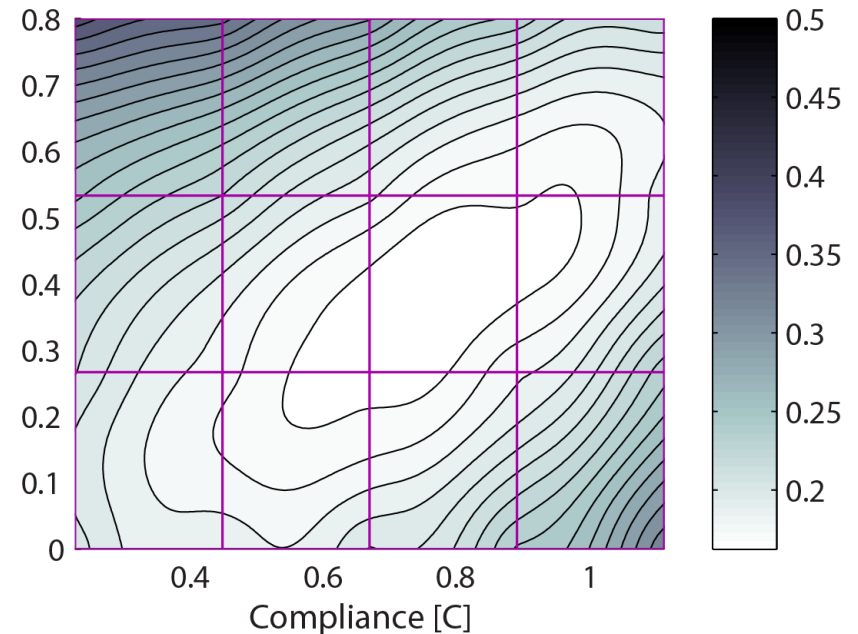
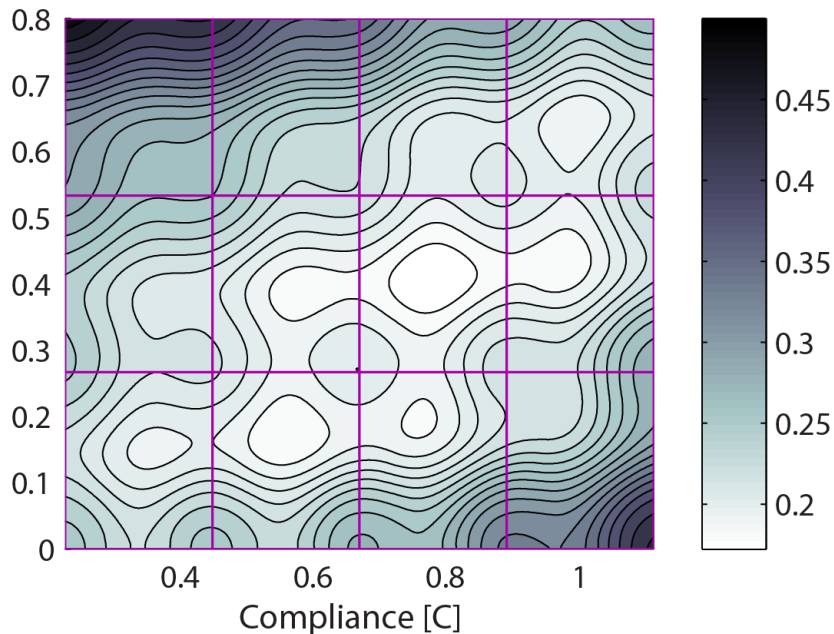
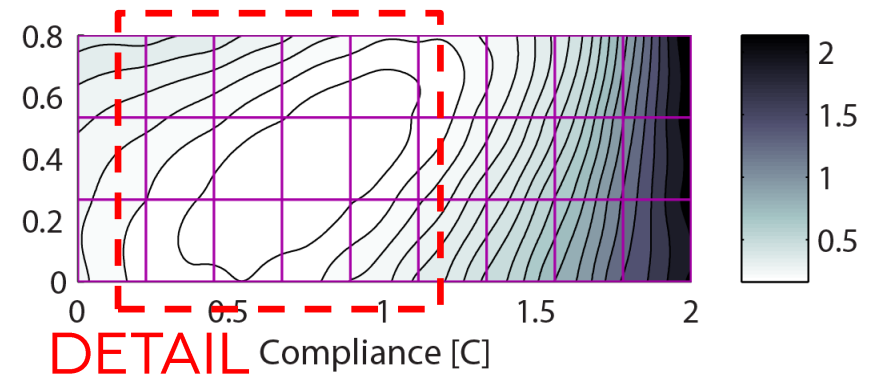

5 - COMPARISON & ANALYSIS

CONVOLUTION (R=0.3)

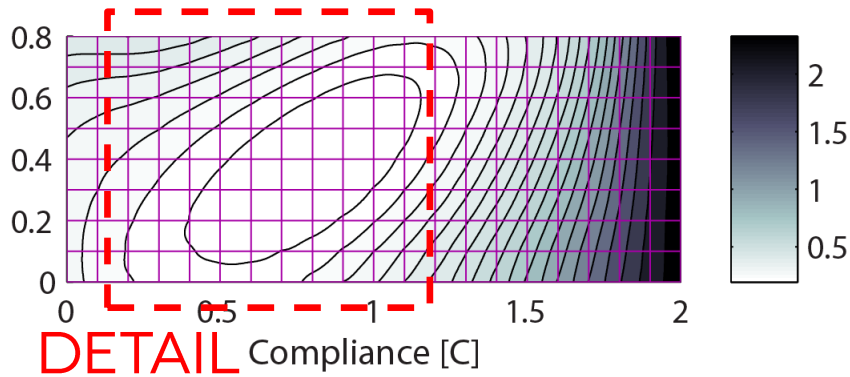

CONVOLUTION (R=0.5)

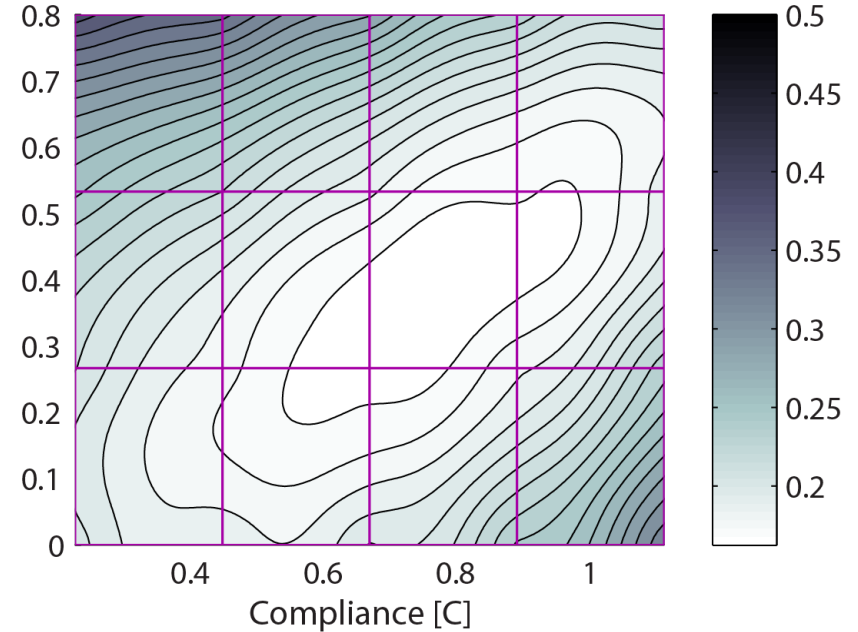
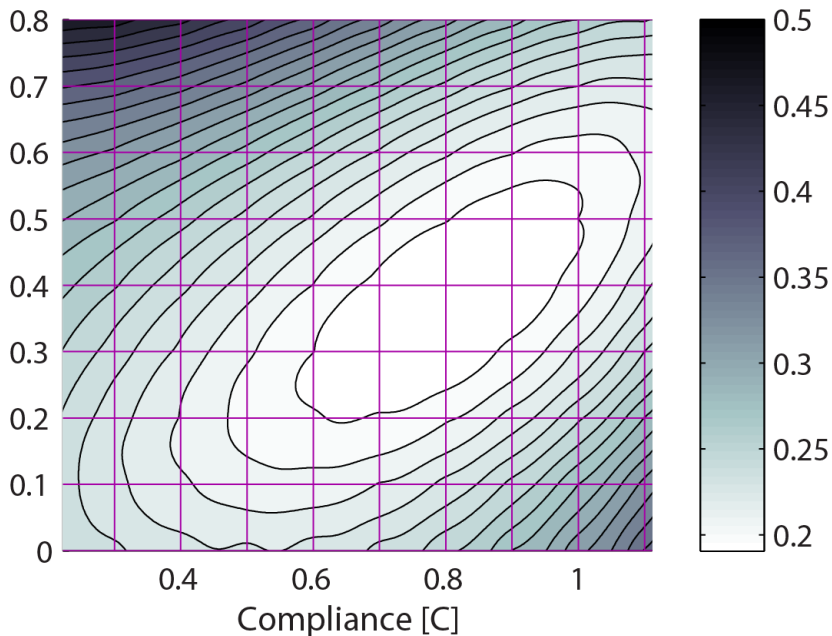
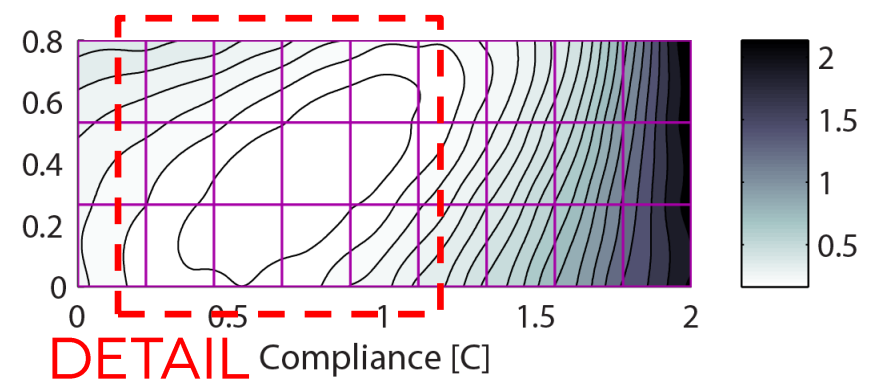

5 - COMPARISON & ANALYSIS

CONVOLUTION (R=0.3)

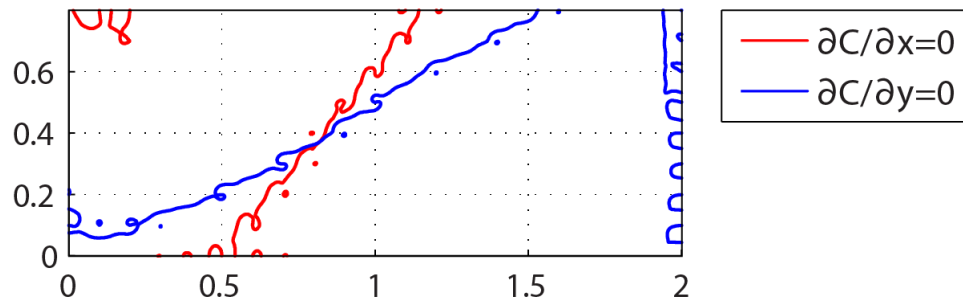
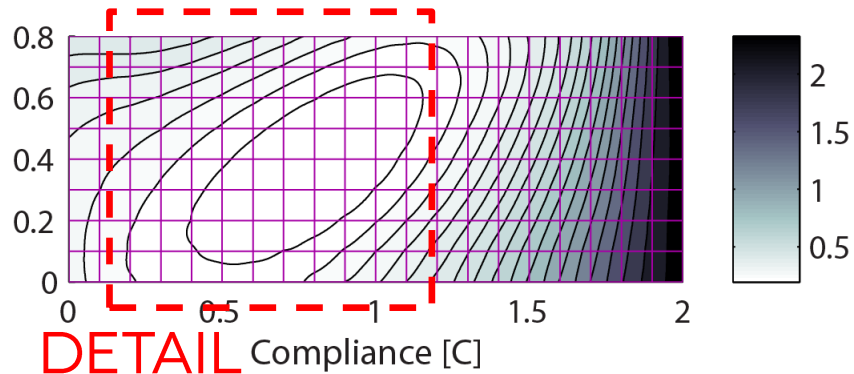

PREVIOUS
CASE

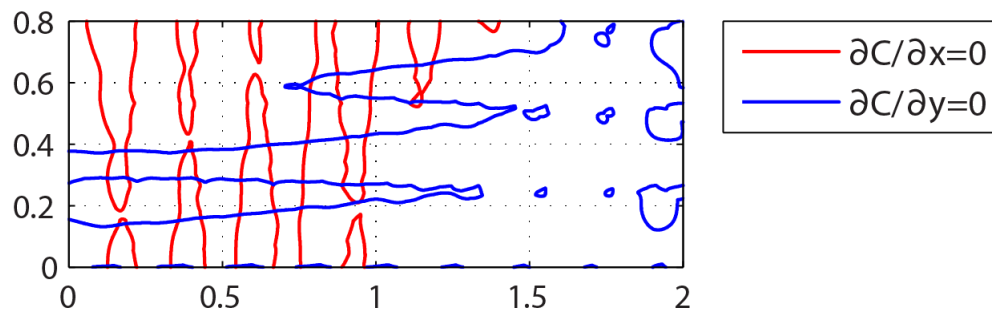

6 – VERIFICATION

- 1D PROBLEM

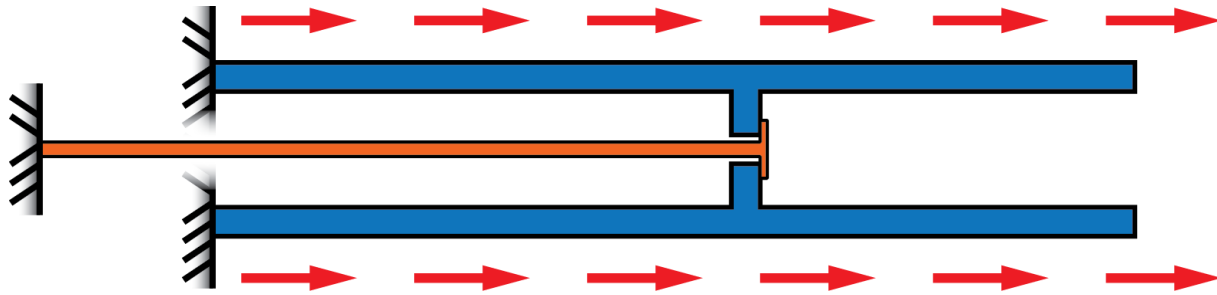

- MODEL IDEALIZATION

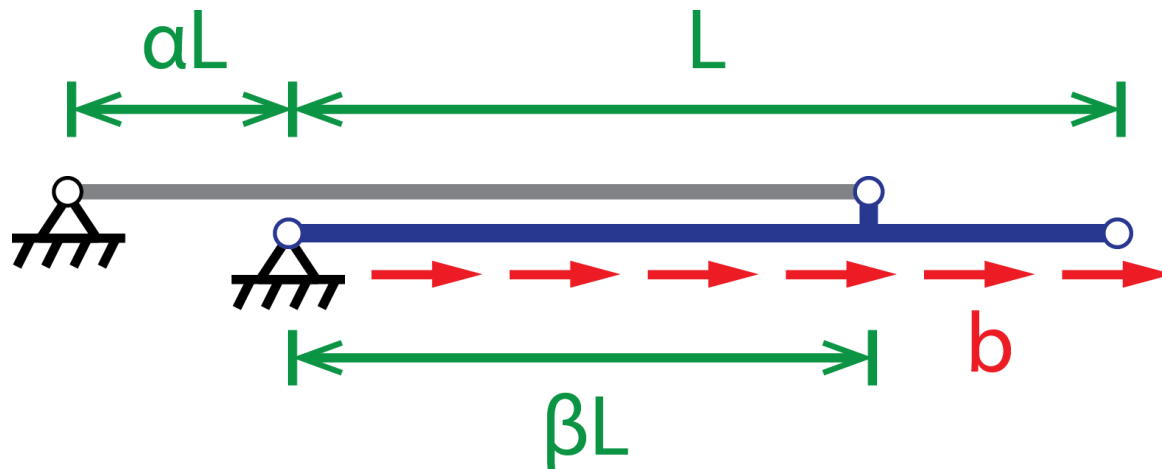

6 – VERIFICATION

- ANALYTICAL SOLUTION

GIVEN

$$\gamma = EA/E_c A_c$$

COMPLIANCE IS

$$C = \frac{b^2 L^3}{12EA} \frac{4\alpha + 4\beta + 4\gamma\beta - 12\gamma\beta^2 + 12\gamma\beta^3 - 3\gamma\beta^4}{\alpha + \beta + \gamma\beta}$$

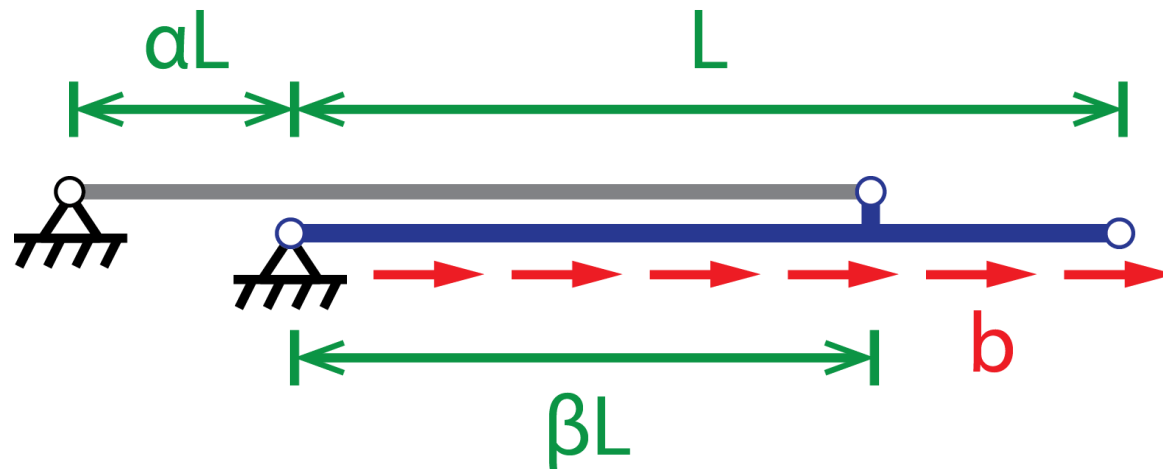

6 – VERIFICATION

- OPTIMAL ANCHOR POINT

$$\beta_c = \frac{1 + \gamma - 2\alpha + \sqrt{1 + 8\alpha + 2\gamma + 4\alpha^2 + 8\alpha\gamma + \gamma^2}}{3 + 3\gamma}$$

, for $\beta_c \leq 1$, and at $\beta_c = 1$ otherwise.

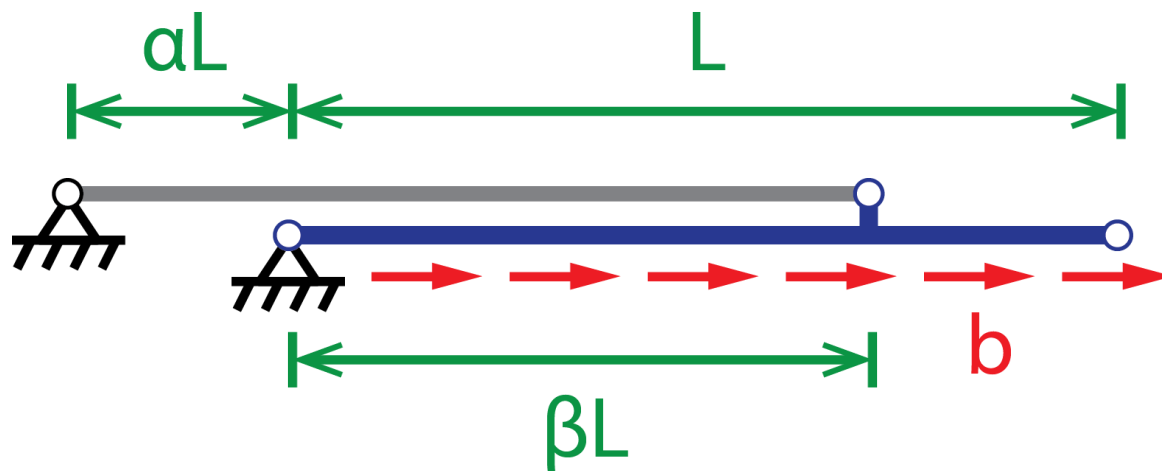

6 – VERIFICATION

20 L2 ELEMS LOAD: B=2
ROD: L=7 $\alpha=2/7$ EA=150
CABLE: AE=210

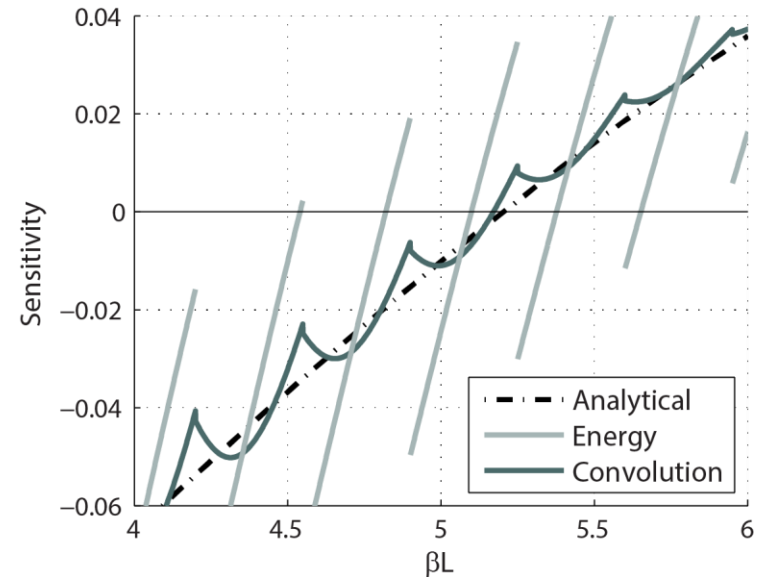
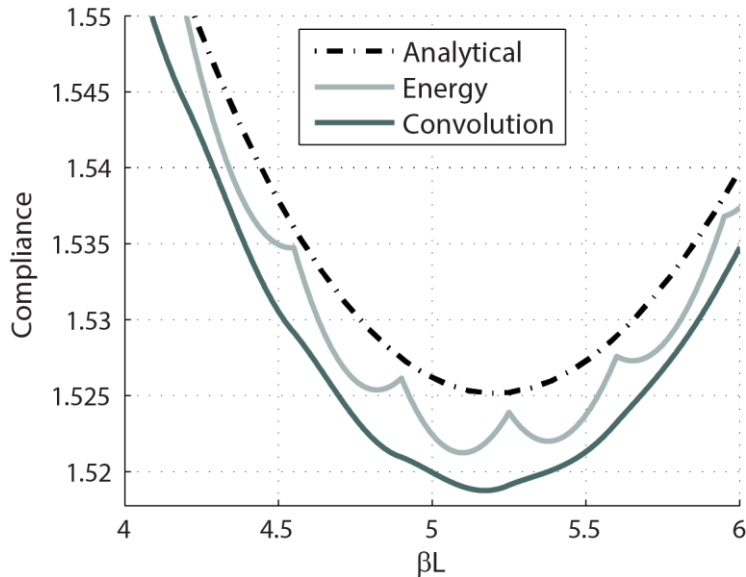
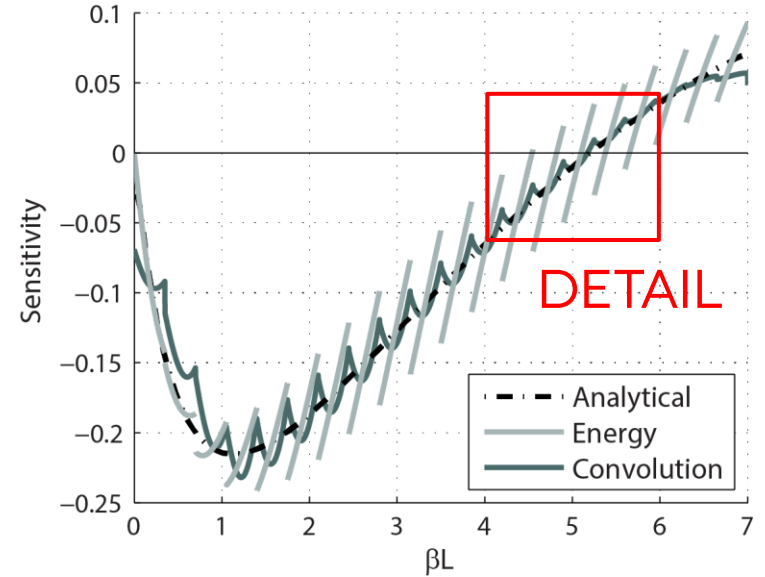
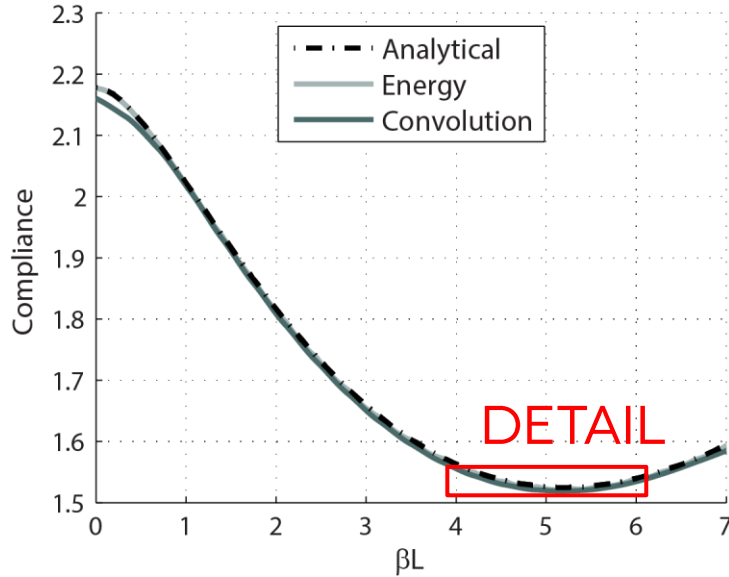

7 – EXAMPLES & RESULTS

- SLAB WITH SUPPORTING CABLES (8X20 Q9)

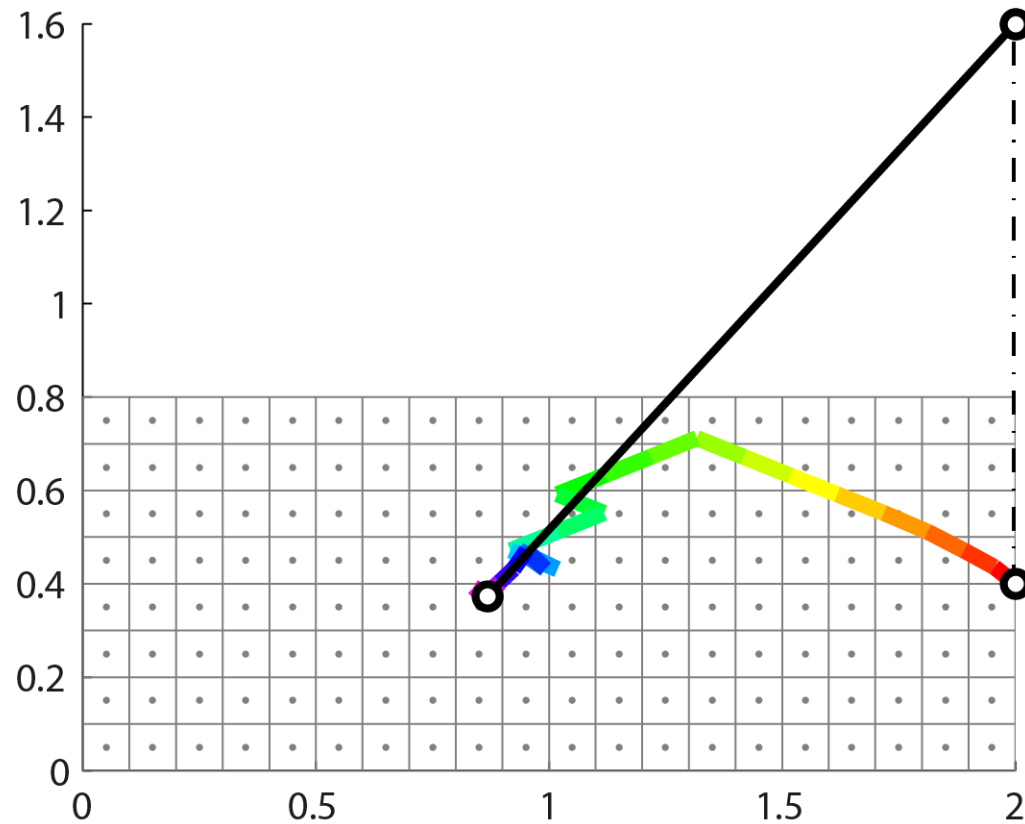

8X20 MESH (Q9 ELEMS)

SLAB: $LX=2$ $LY=0.8$ $E=100$ $\nu=0.3$

CABLE: $AE=300$

LOAD: $B=[0 \ -2]$

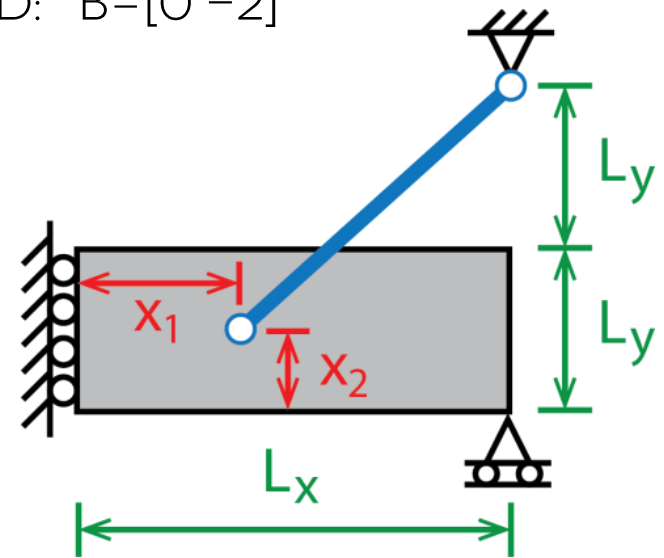

7 – EXAMPLES & RESULTS

- DOUBLE CORBEL (UNSTRUCTURED MESH)

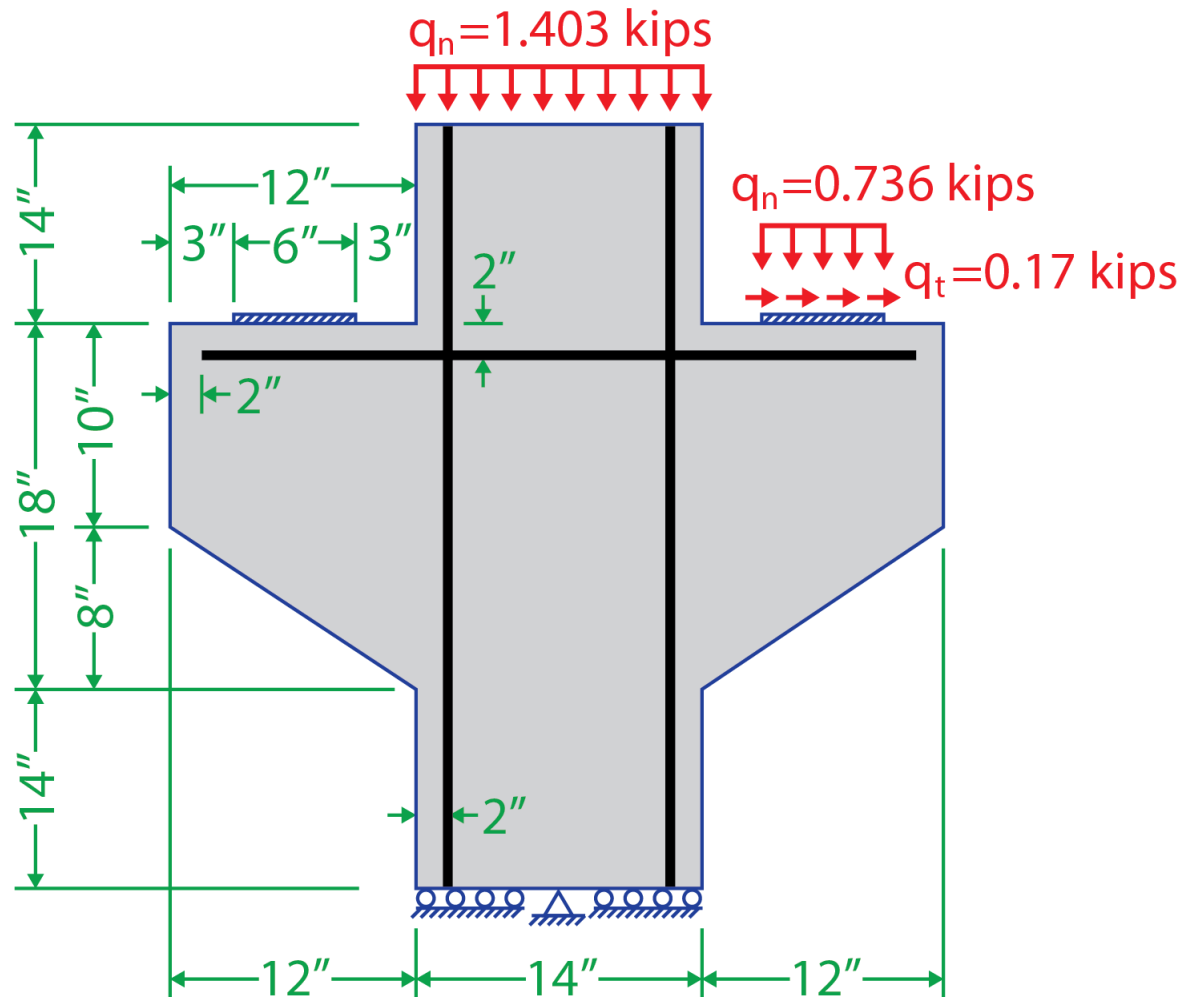

7 – EXAMPLES & RESULTS

- DOUBLE CORBEL (UNSTRUCTURED MESH)

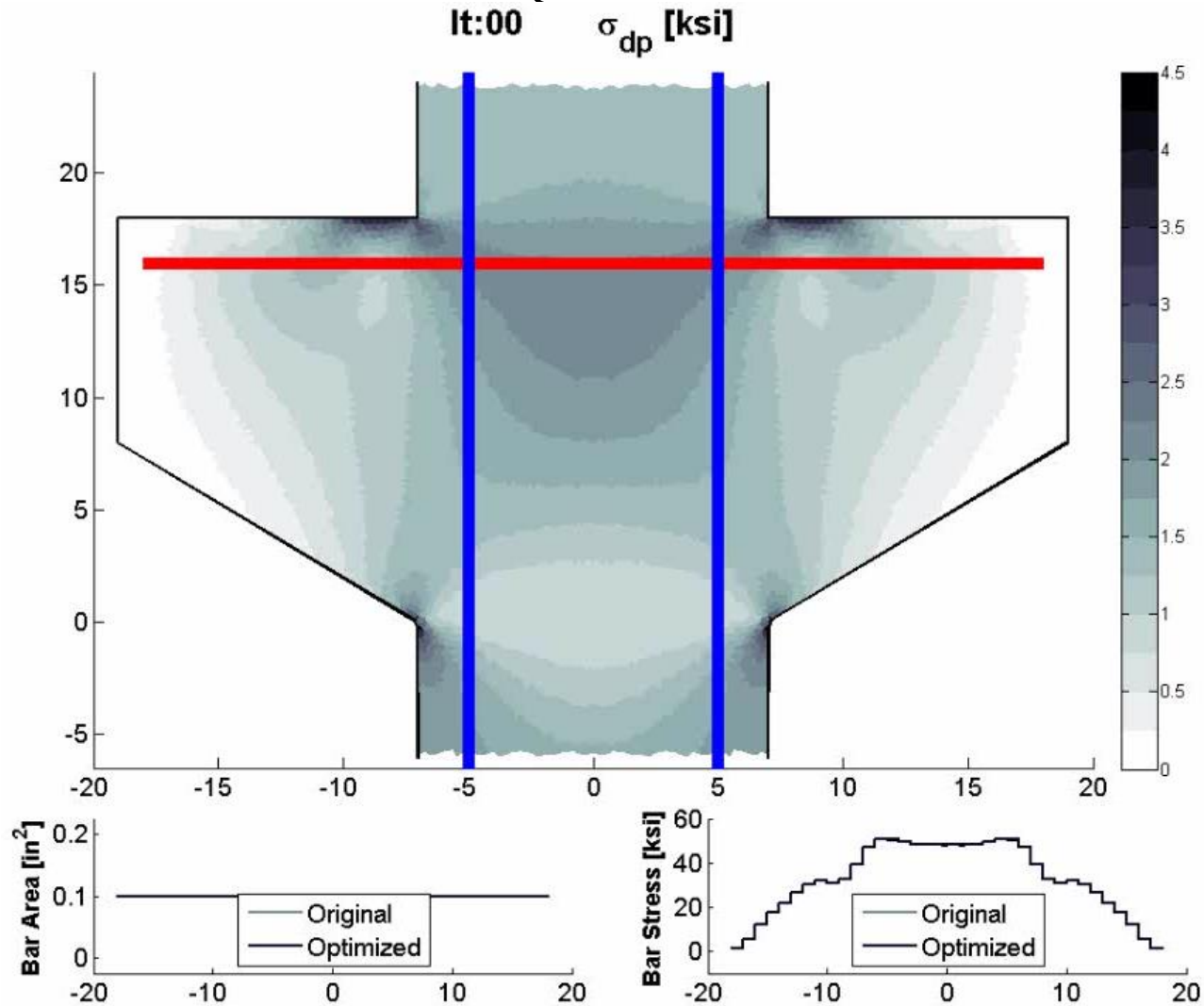

7 – EXAMPLES & RESULTS

- DOUBLE CORBEL (UNSTRUCTURED MESH)

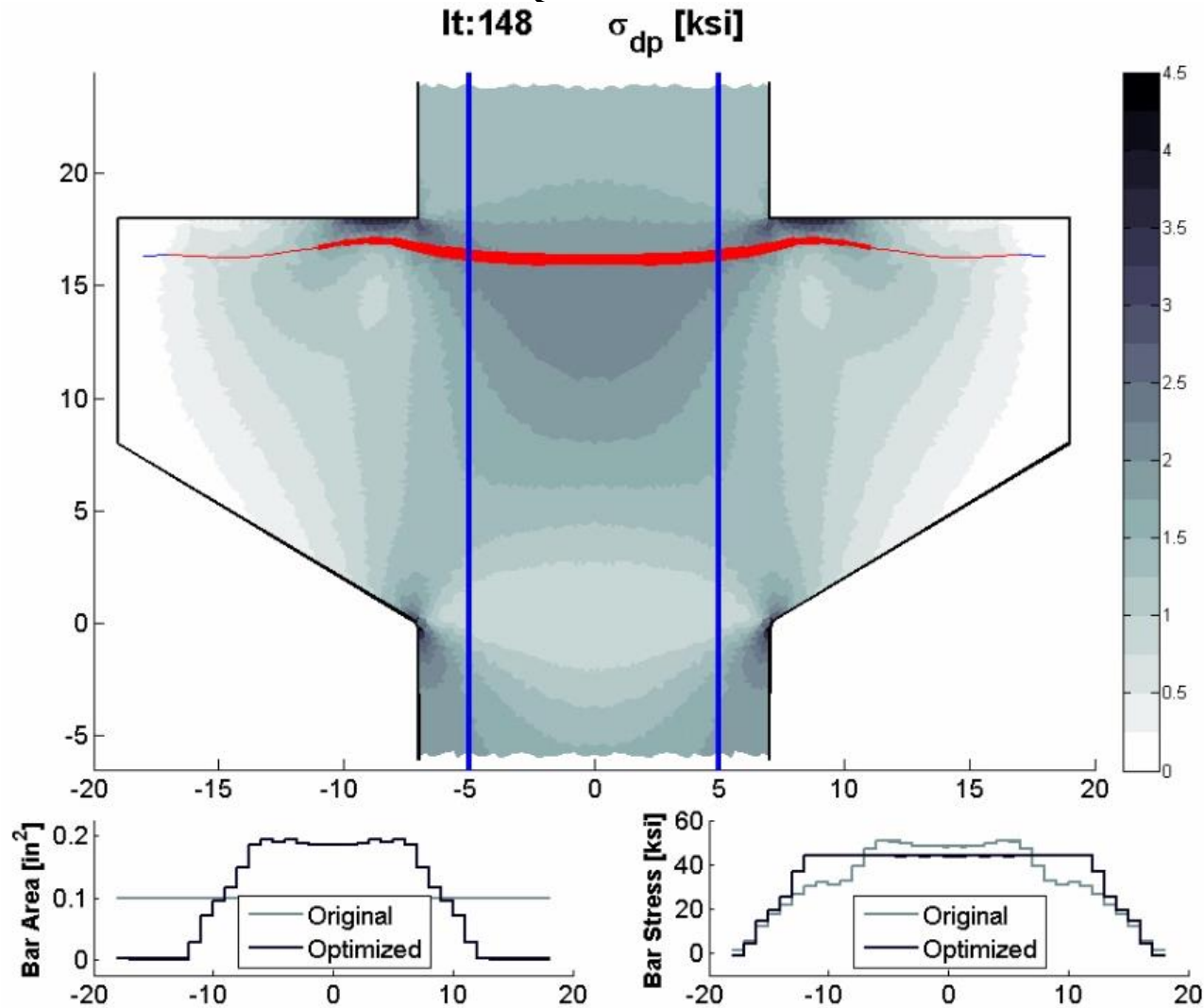

7 – EXAMPLES & RESULTS

- DOUBLE CORBEL (UNSTRUCTURED MESH)
 - INTERPRETATION

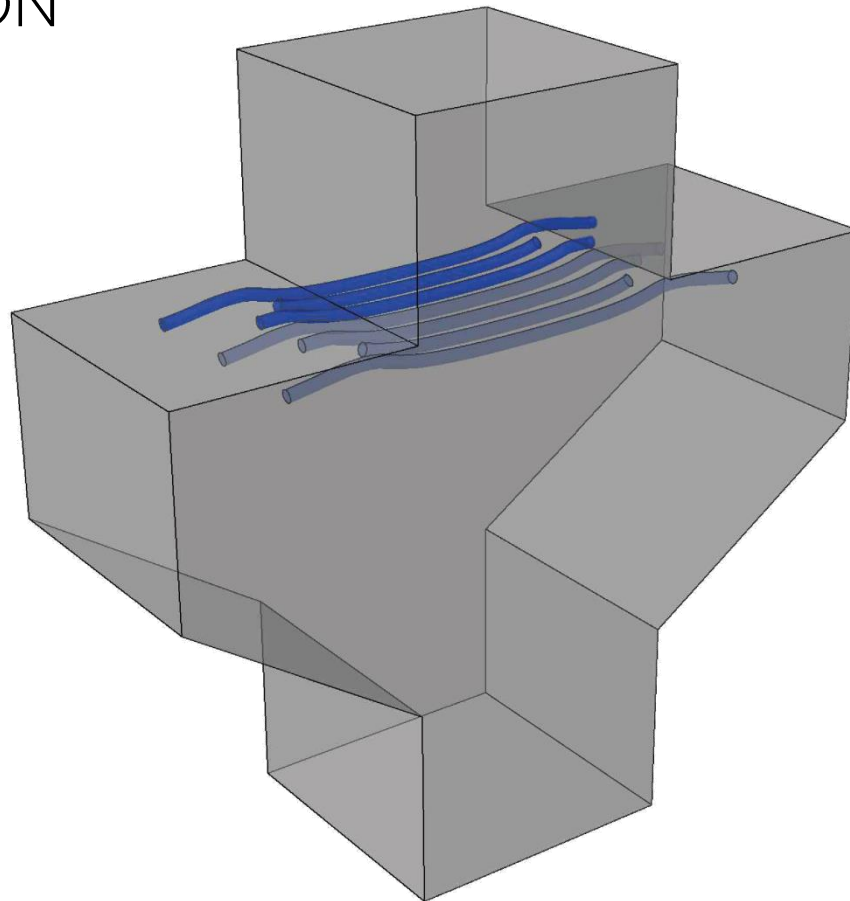

8 – CONCLUSIONS

- PROBLEM WITH TRADITIONAL COUPLING
- CONVOLUTION COUPLING
 - SIMPLE
 - FAST
 - ERROR DECREASES WITH REFINEMENT
 - IT WORKS!!!
- HELPS BRIDGE THE GAP BETWEEN CONTINUUM AND DISCRETE OPT

THE END

